

ROUND DOWNSPOUT + ACCESSORIES

ELBOWS ③

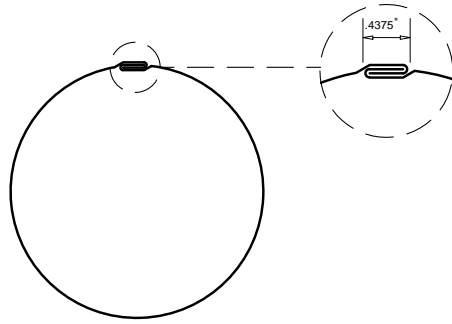

ROUND DOWNSPOUT

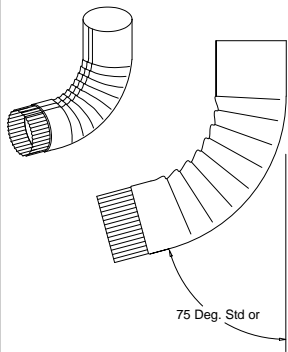
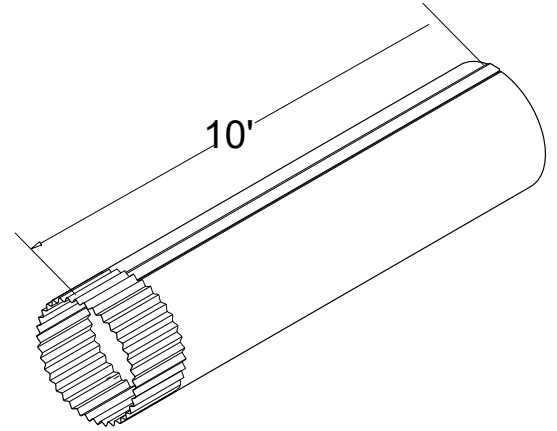

ONE-PIECE OFFSETS ③

"UP" STYLE (EAVE)

"DOWN" STYLE (LEDGE)

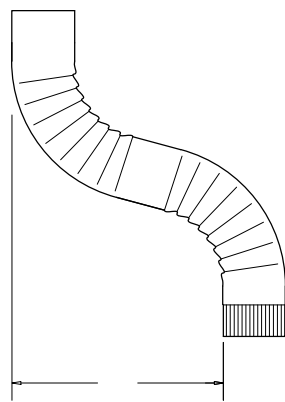
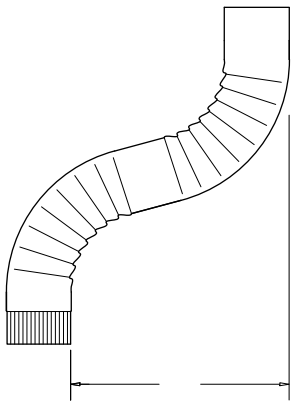

OUTLET TUBES

STRAPS

TYPE A-FLAT TOP

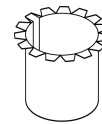

TYPE B-HALF-ROUND TOP

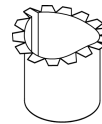

1.625" WIDE WITH .25" HEM



SIZE:

- | | |
|---|--|
| <input type="checkbox"/> 3" ROUND DOWNSPOUT ① | <input type="checkbox"/> 7" ROUND DOWNSPOUT ③ |
| <input type="checkbox"/> 4" ROUND DOWNSPOUT | <input type="checkbox"/> 8" ROUND DOWNSPOUT ③ |
| <input type="checkbox"/> 5" ROUND DOWNSPOUT | <input type="checkbox"/> 9" ROUND DOWNSPOUT ③ |
| <input type="checkbox"/> 6" ROUND DOWNSPOUT | <input type="checkbox"/> 10" ROUND DOWNSPOUT ③ |

NOTES:

- ① Not available in 22ga steel or .050 aluminum.
- ② For products/material not listed, please inquire.
- ③ Elbows and offsets that are 7" and larger will be mitered and caulked.

MATERIAL ②

| | |
|---|---------------|
| 22GA STEEL | .032 ALUMINUM |
| 24GA STEEL | .040 ALUMINUM |
| 26GA STEEL (limited color availability) | .050 ALUMINUM |
| 22GA STAINLESS STEEL | 16OZ COPPER |
| 24GA STAINLESS STEEL | 20OZ COPPER |
| 26GA STAINLESS STEEL | |

COLOR: _____

QUANTITIES:

- ____ LINEAL FEET @ 10'-0" LENGTHS
 ____ OUTLETS STYLE A ____ STYLE B
 ____ ELBOWS (STD. 75°) ③
 ____ ELBOWS (CUSTOM DEGREE) ____ °
 ____ ONE-PIECE OFFSETS " OFFSET AMOUNT ③
 ____ STRAPS (STANDARD =2 PER 10' DOWNSPOUT)

PRINT APPROVED BY:

 (SIGNATURE) (DATE)

A SIGNED PRINT APPROVAL SIGNIFIES A CUSTOMER HAS VERIFIED ALL DIMENSIONS, SIZES, QUANTITIES, AND MATERIAL TYPES.

FABRICATION WILL PROCEED ONLY AFTER RECEIPT OF SIGNED PRINT APPROVAL

PROJECT INFORMATION

 (PROJECT NAME)

 (ARCHITECT)

 (CUSTOMER)

 (REPRESENTATIVE/DISTRIBUTOR)

Roof Drainage Components & Accessories, Inc

60 Don Wesbrook Ave North
 Jasper, GA 30143

706-692-7333

sales@rdcaa.com

www.rdcaa.com